

50MM EXTRUDED VISION ROLLER SHUTTER

(Commercial)



This roller shutter range is made with a precision extruded roller shutter profile, with approximately 20% vision and ventilation perforations, and is suitable for many commercial and industrial grade applications.

SUITABLE APPLICATIONS

- Commercial Windows.
- Commercial Shop Fronts & Doorways.
- Garage Doors.
- Protection for Factories, Warehouses, Clubs, Pubs & Hotels, Restaurants, Pharmacies, Sports Complexes, Arcades, Shopping Mall Entrances & Shopping Centre Grilles.

FEATURES

- High quality, strong aluminium alloy construction.
- Commercial grade single wall extruded profile for heavy duty strength.
- Vision and ventilation perforations for airflow and light.
- High quality powder coated finish for maximum abrasion resistance.
- Perforated and curved face profile.
- Roll-tight design.
- Range of colours.
- Heavy duty steel axle with high quality internal sealed bearings.
- Suitable for widespan widths up to 5500mm.
- Can be manually operated or motorised.
- Made in Australia.

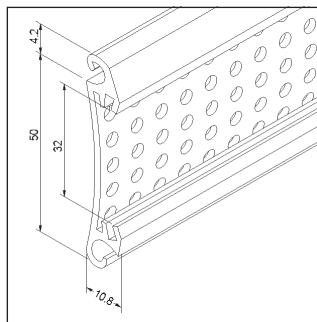
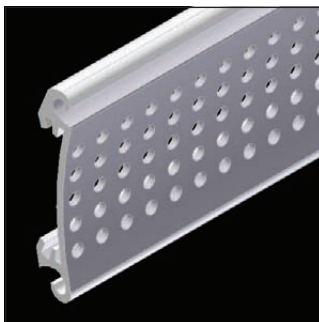

TECHNICAL SPECIFICATIONS

Maximum Shutter Width	5500mm
Maximum Shutter Height	3000mm
Maximum Surface Area	9m ²
Curtain Weight/Metre ²	8.5kg
Number Of Slats/Metre	20
Profile Slat Covering	50mm
Profile Slat Thickness	10.8mm
Axle Types	Octagonal Steel
Bottom Bar Dimensions	67mm x 10mm
Guide Dimensions	68mm x 25mm/18mm
Paint Finish	High Quality Powder Coat Finish

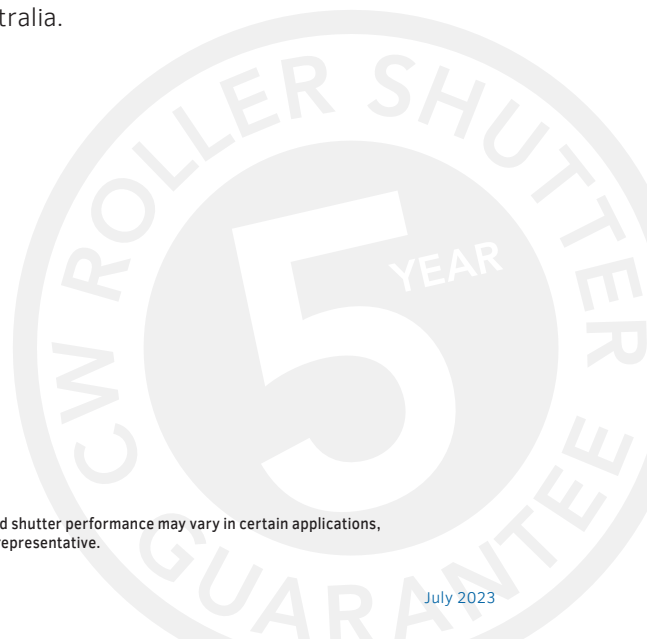

MADE TO MEASURE ROLLER SHUTTERS













PELMET SIZES & MAXIMUM SHUTTER HEIGHT STANDARD SLAT LOCKS

Pelmet Box Size	Max. No. Of Slats	Max. Shutter Height (Including Pelmet)	Axle Size
180mm	34	1750mm	70mm
205mm	46	2350mm	70mm
230mm	58	2950mm	70mm
250mm	59	3000mm	130mm with adaptor

WINGED SLAT LOCKS

180mm	24	1250mm	60mm
205mm	37	1900mm	70mm
230mm	45	2300mm	70mm
250mm	51	2600mm	101mm with adaptor
300mm	59	3000mm	130mm with adaptor

ROLLER SHUTTER COLOUR OPTIONS

Profiles	Pelmets/Side Frames/Guides/Bottom Bars
 White	 Cream
 Black	 Magnolia Cream
 Anodised Silver	 Clear Beige
	 White
	 Shale Grey
	 Brown
	 Black
	 Monument
	 Woodland Grey

Powder coated options available (charges apply).

Coastal Treatment for side frames is strongly recommended for shutters installed close to beach or other salt water environments. Request Coastal Treatment on your order.

CONTROL OPTIONS

Manual Options



Steel Cable Winder (Up To 50Kg)*



Spring Loaded With Key Lock



Remote Control With SolarSmart™ Plus Automation 12V Motor (Up To 50Kg)*



Remote Control (Key Ring Transmitter) With 240V Electric Motor & Multi-Function SIMU SD100 Hz Radio Receiver & Control Unit*



PowerSmart™ Control System With 12V Motor (Up To 50Kg)*



Wall Switch With 240V Electric Motor*



Remote Control With 240V Electric SIMU Hz Motor*

Motorised Options (continued)



Key Switch With 240V Electric Motor*



Crank Handle With 240V Electric Manual Override Motor

* Control options must be installed in an indoor environment.

CW Products recommends the use of Photo Safety Cells, a Safety Brake and/or a Safety Edge when installing automated roller shutters over openings and doorways. Especially when the roller shutter is not in full view of the operator (eg. when using a remote control or wall switch positioned away from the roller shutter and out of view). When using a wall switch, we recommend a spring return switch/deadman switch.

To order please complete a **CW Products Made To Measure Roller Shutter Order Form**.